

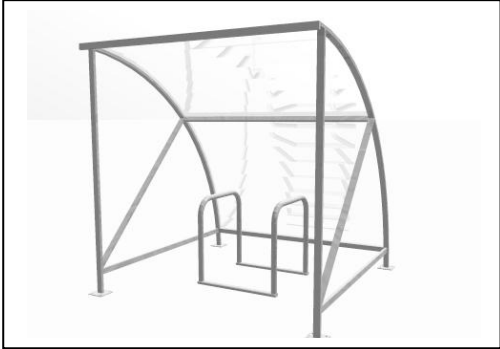

3 D Lee Moor Business Park
Rennington, Alnwick
NE66 3RL

Tel 01665577022
Fax 01665577901

ECO CYCLE SHELTER RANGE



Product Name: Eco Cycle Shelter and Rack

Product Code: USP/ES4/2HR

Size: 2050 mm Long x 2040 mm Wide x 2100 mm High

Description: 4 Cycle Capacity Shelter Complete with Sheffield toast rack

Price: £ 756.00 plus Vat

Total Price including Vat £ 907.20

Side Panel option Kit £ 252.00 plus Vat Total for side panel kit including vat £ 302.40

LEAD TIME EX STOCK 4 TO 5 DAYS

Carriage: Free UK Mainland delivery (other destinations please telephone for a quote)

Product information: The Cycle Shelters are made with a mild steel frame and are Plate Mounted Bolt down. The Eco Cycle Shelter is very easy to assemble and is delivered flat pack. The shelter is lightweight yet robust and being galvanised will give maximum protection from rust for many years. This is a full size shelter and will take up to 10 adult cycles. The assembly is very straight forward. The shelters are available in Galvanised finish only however if you want a painted shelter, simply assemble the frame and paint it to the desired colour (leave it to dry) and then fit the sheeting. To hand paint a shelter will only take about 45 minutes.

The Cycle Rack is manufactured with 50 mm diameter tube and is also fully galvanised to BS EN ISO 1461:1999. Complete with flanges for bolting directly to suitable ground surface. Easy to fit and supplied as a full section so no assembly other than ground fixing.

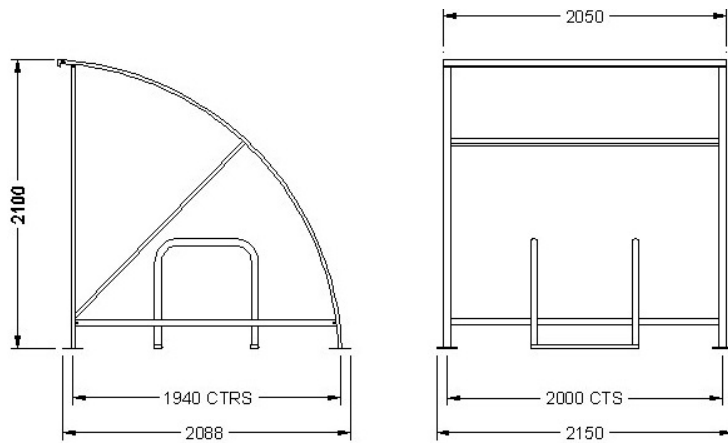

Pads Foundations:

C35 Concrete set on firm bed of sand or clay

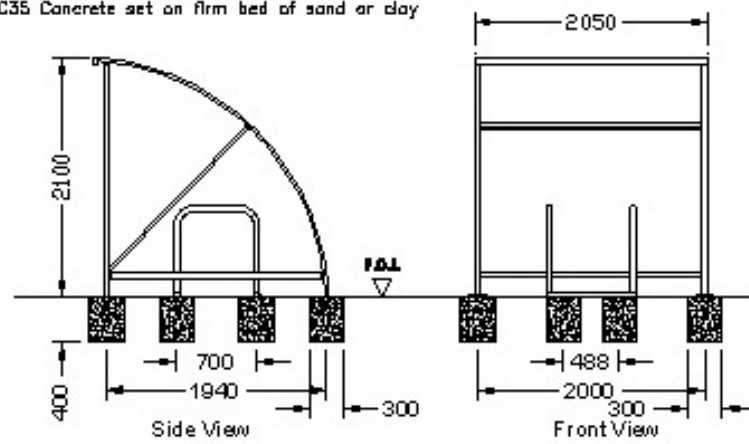

Plinth Foundations:

C35 Concrete set on firm bed of sand or clay

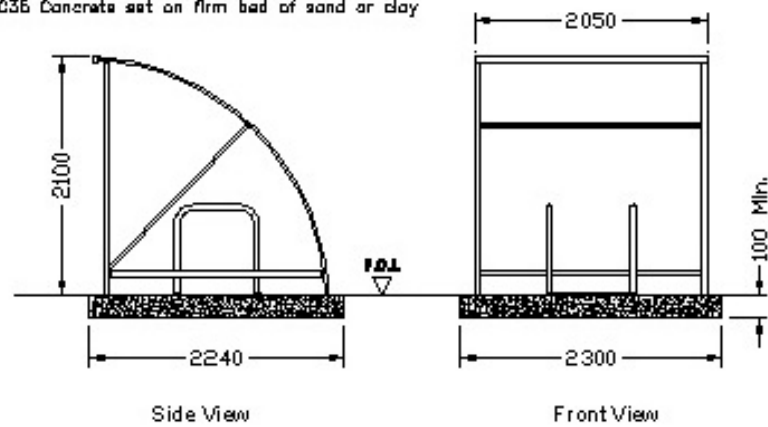

To order this product please telephone 01665577022 or email sales@urbanfab.com. We will need to know the delivery address including post code and how soon you want delivery. The shelter is manufactured in large sections however assembly is a straight forward two person job.



Product Code USP/ES4/2HR

